

# KENAY

LOFT SOFÁ  
LOFT SOFÁ /  
LOFT DIVANO /  
LOFT CANAPÉ /  
LOFT SOFA /  
LOFT SOFA

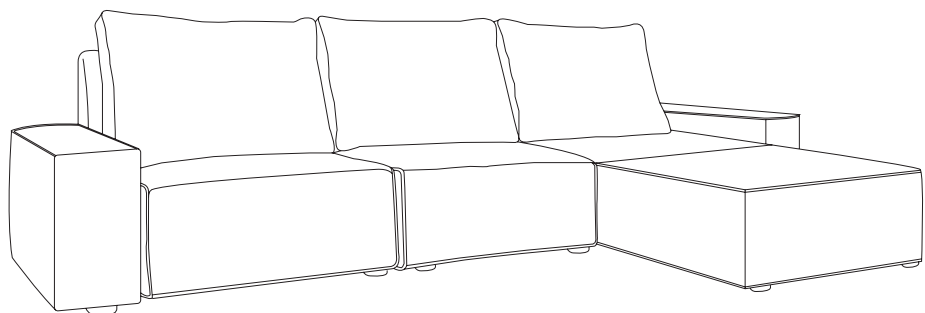
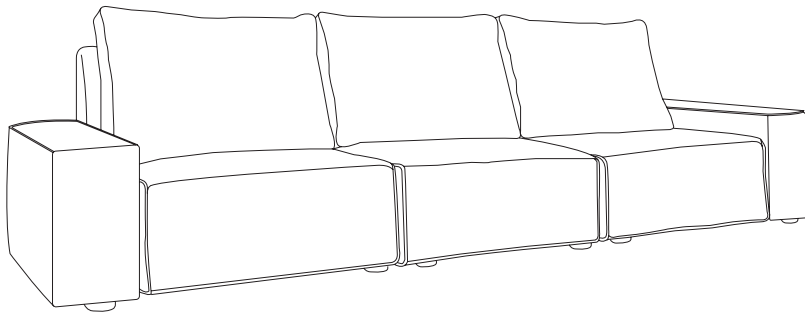

MEDIDAS GENERALES

\* Cotas en cm

ES

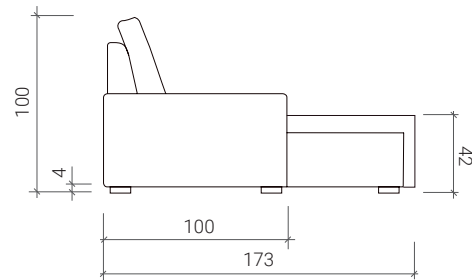
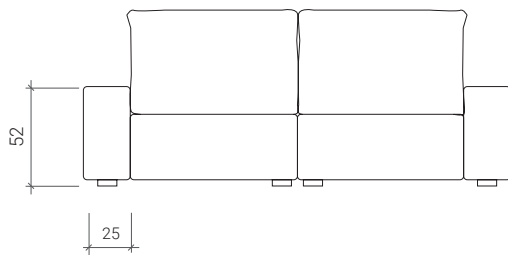
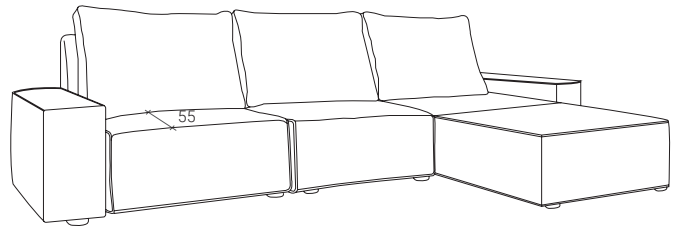
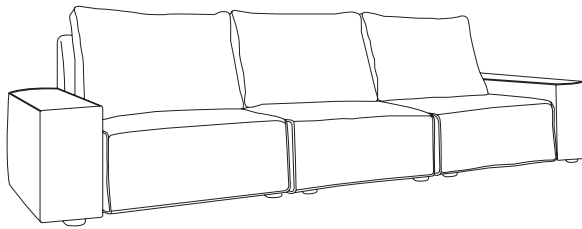

CARACTERÍSTICAS TÉCNICAS

ESTRUCTURA

- Madera maciza recubierta de goma y fibra termofusionada.
- Bastidor de cinchas elásticas entrecruzadas

COMPOSICIÓN

- Asiento y respaldo: Goma de 30 kg de alta resistencia recubierta de fibra termofusionada antialérgica.
- Patas: PVC (ocultas). Acabado negro.

COJINES DECORATIVOS

- Incluye 2 cojines de 40 x 40 cm en modelos con chaise longue.

ESPECIFICACIONES DE MONTAJE

- No requiere montaje. Únicamente es necesaria la unión entre módulos mediante pletinas ya instaladas.

Asiento extraíble	No
Respaldo reclinable	No
Desenfundable	- Asientos - Respaldos
Arcón	No
Opción brazos desmontables	No
Módulo rincón	Sí

COMPOSICIONES

SIN CHAISE LONGUE

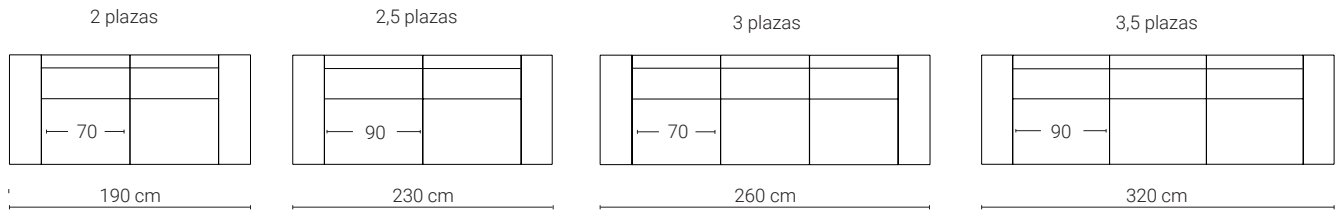

CON CHAISE LONGUE

\* La posición de la chaise se indica mirando de frente el sofá.

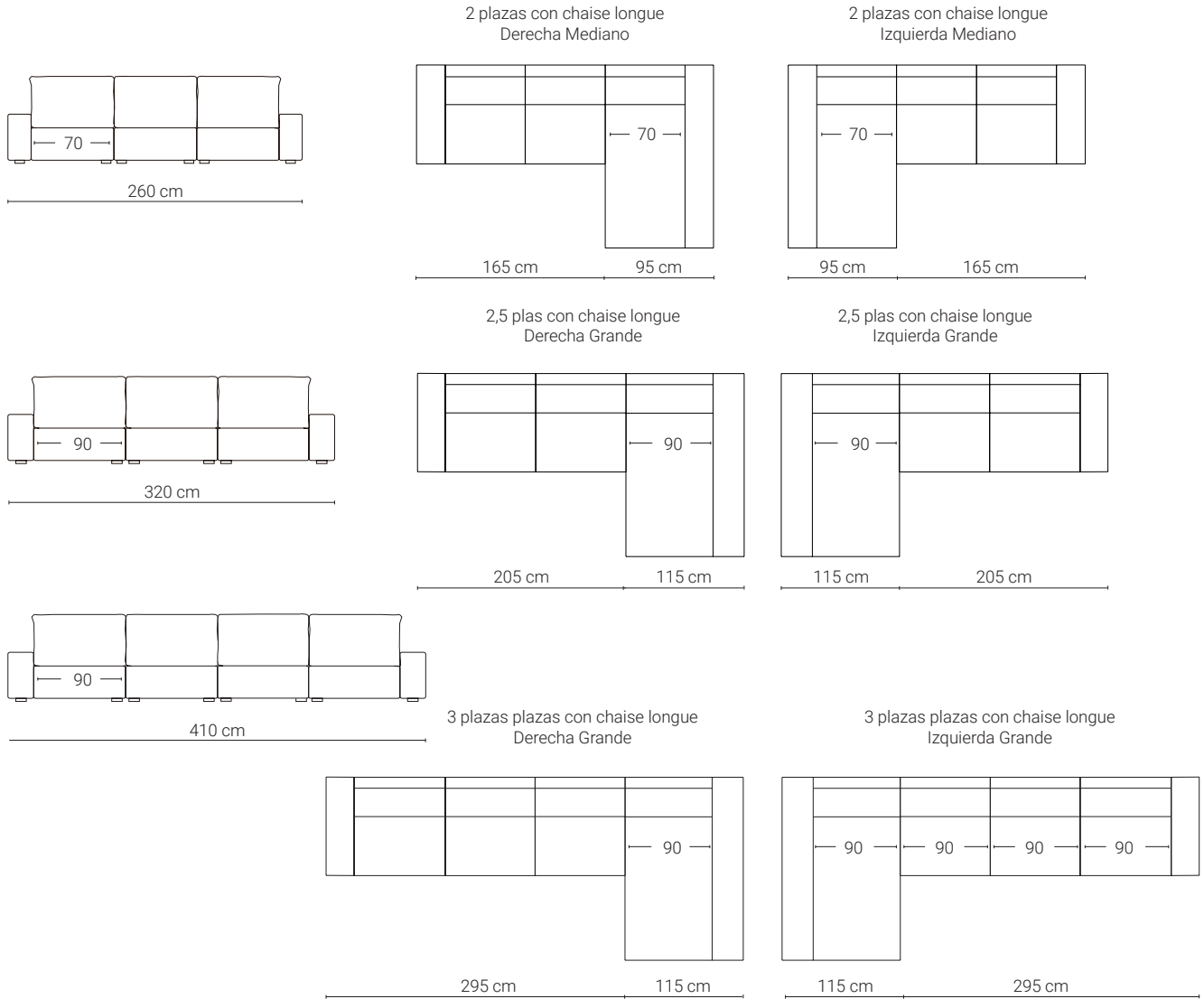

CON PUF

\* La posición del puf se indica mirando de frente el sofá.

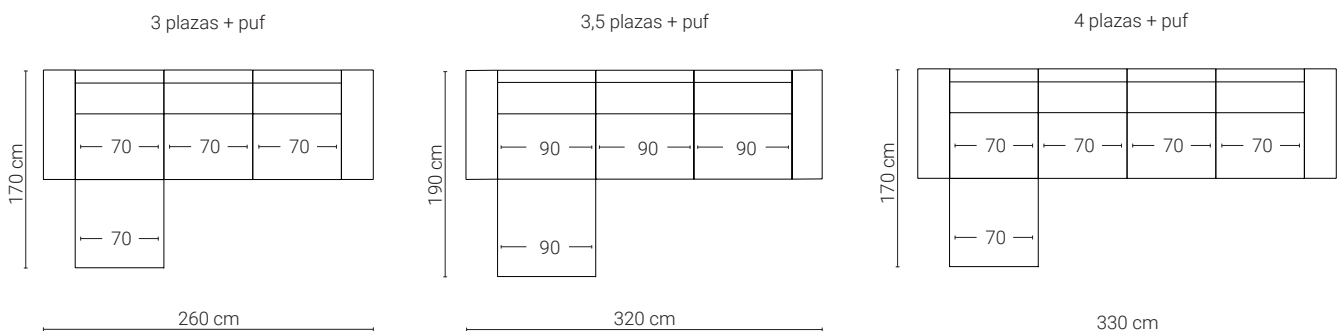

\* Existe una tolerancia de ± 2 cm por módulo.

COMPOSICIONES

ES

CON PUF

\* La posición del puf se indica mirando de frente el sofá.

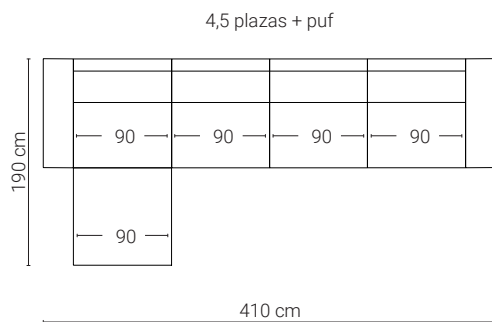

RINCONERA

\* La posición del puf se indica mirando de frente el sofá.

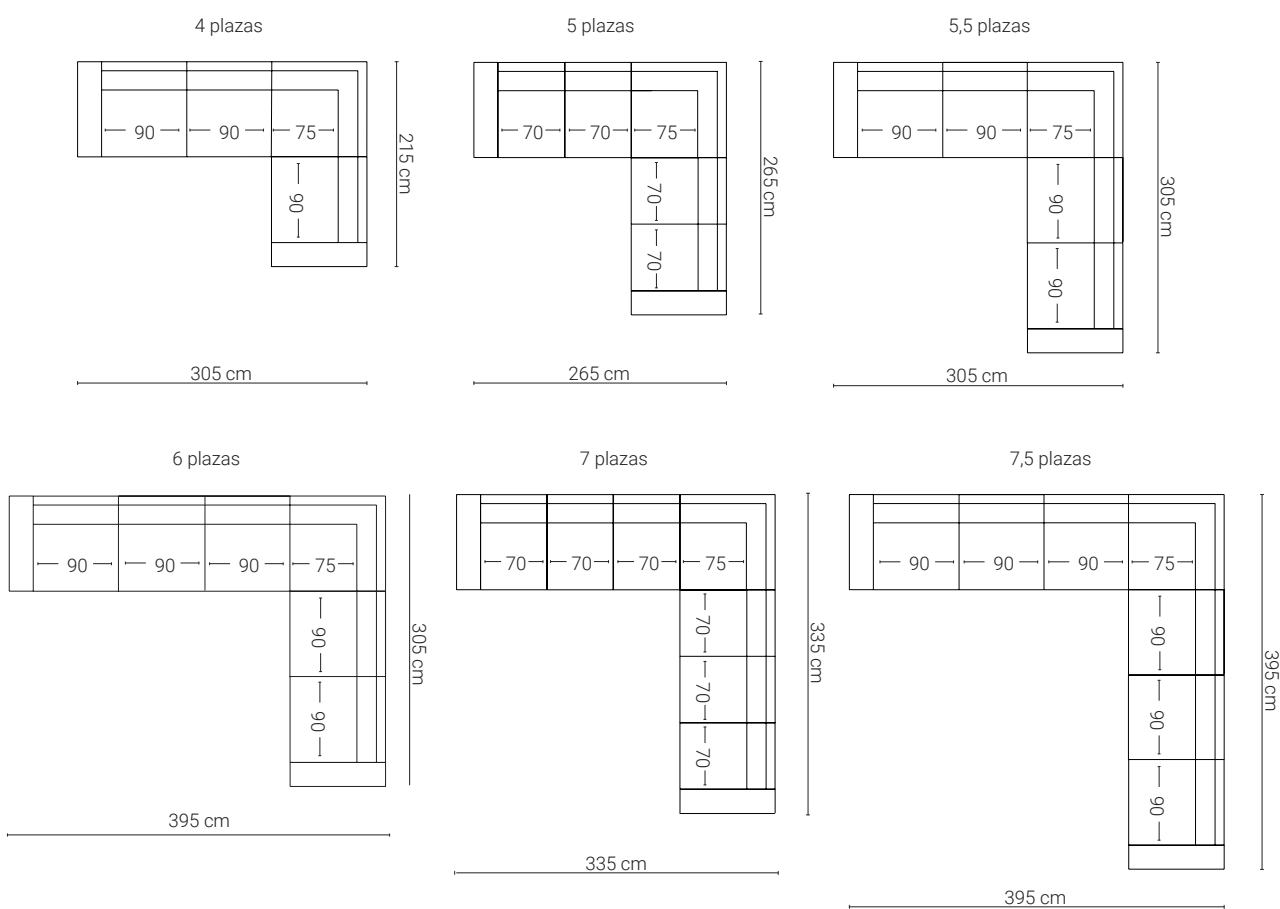

RINCONERA + PUF

\* La posición del puf se indica mirando de frente el sofá.

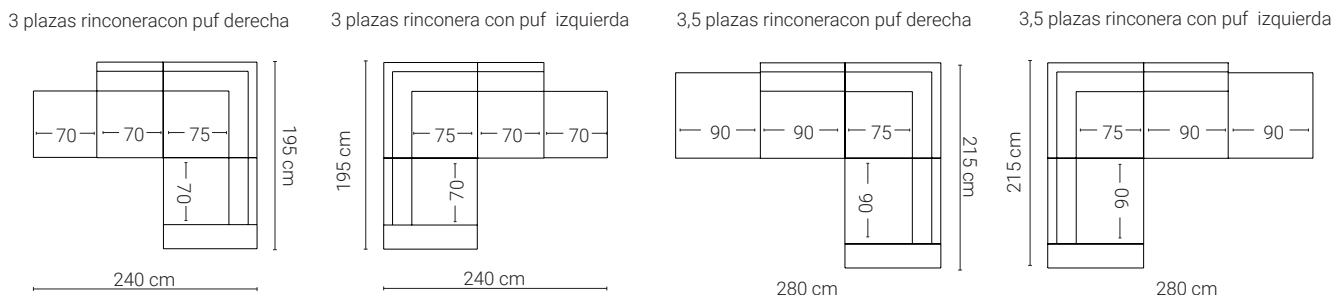

\* Existe una tolerancia de  $\pm 2$  cm por módulo.

MEDIDAS GERAIS

\* Dimensões em cm

PT

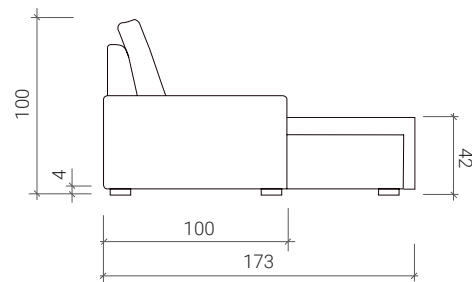
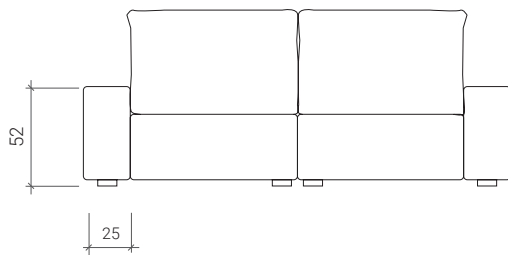
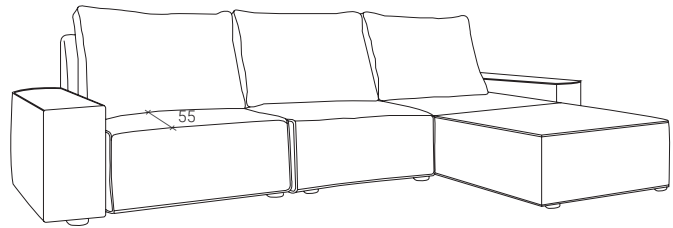
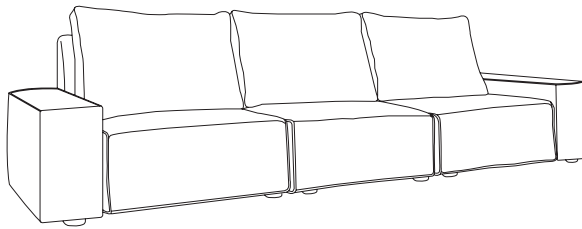

CARACTERÍSTICAS TÉCNICAS

ESTRUTURA

- Madeira maciça revestida de borracha e fibra termofundida.
- Estrutura de cintas elásticas entrecruzadas.

COMPOSIÇÃO

- Assento e encosto: Borracha de 30 kg de alta resistência revestida com fibra termofusionada antialérgica.
- Pés: PVC (ocultas). Acabamento preto.

ALMOFADAS DECORATIVAS

- Inclui 2 almofadas de 40 x 40 cm nos modelos com chaise longue.

ESPECIFICAÇÕES DE MONTAGEM

- Não requer montagem. Apenas é necessário a união entre módulos através de placas já instaladas.

Assento removível	Não
Encosto reclinável	Não
Removível	- Assentos - Encostos
Baú	Não
Opção de braços removíveis	Não
Módulo de canto	Sim

COMPOSIÇÕES

SEM CHAISE LONGUE

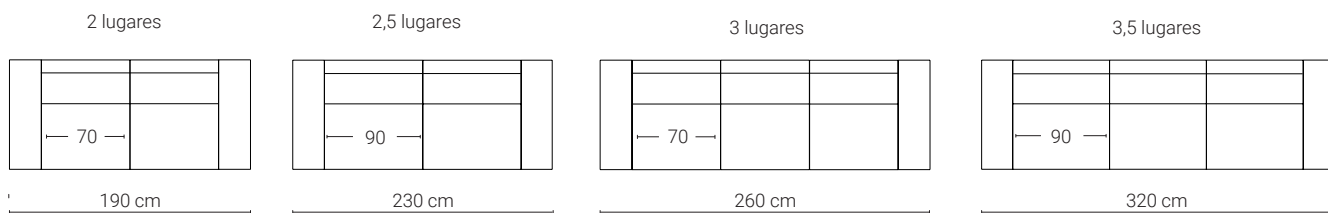

COM CHAISE LONGUE

\* A posição do chaise é indicada olhando de frente para o sofá.

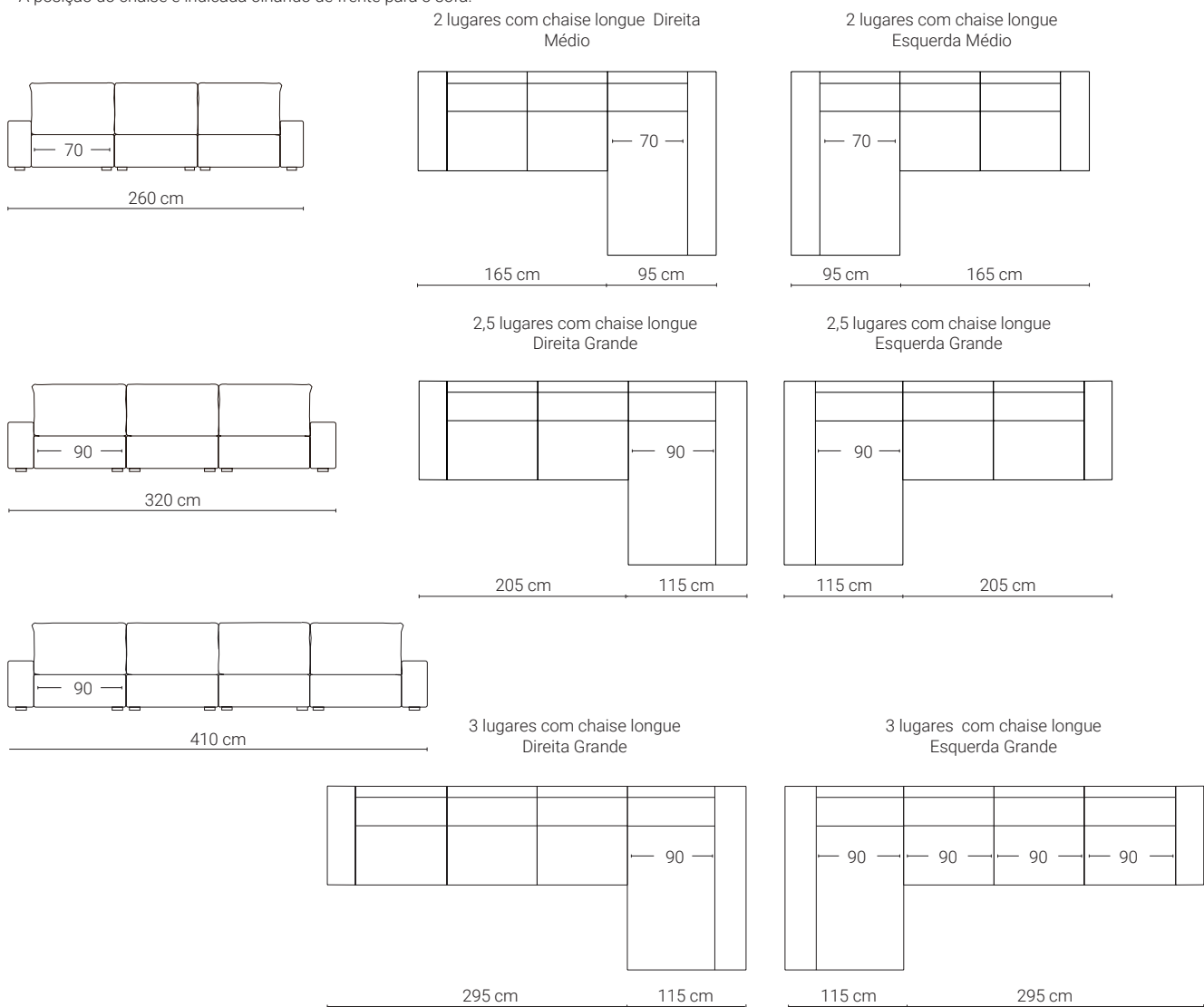

Com PUFE

\* A posição do puff é indicada olhando de frente para o sofá.

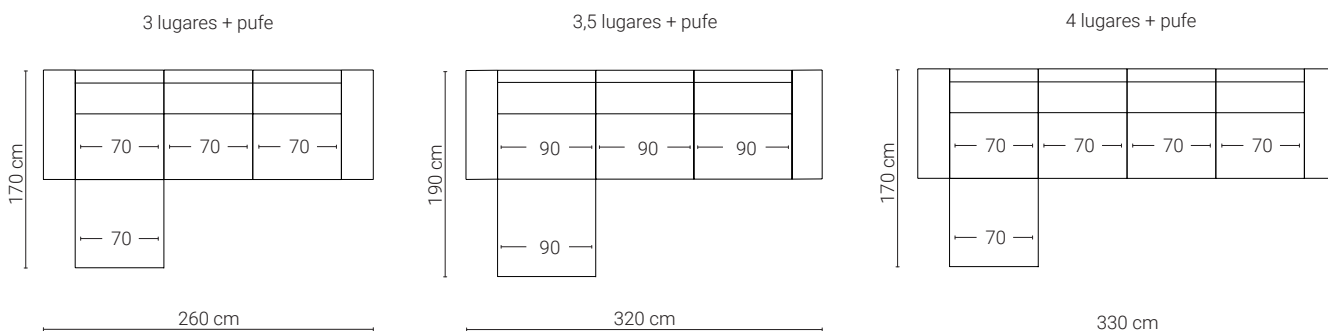

\* Existe uma tolerância de  $\pm 2$  cm por módulo.

COMPOSIÇÕES

PT

Com PUFE

\* A posição do puff é indicada olhando de frente para o sofá.

4,5 lugares + pufe

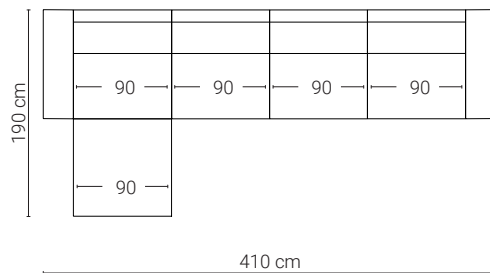

DE CANTO

\* A posição do puff é indicada olhando de frente para o sofá.

4 lugares

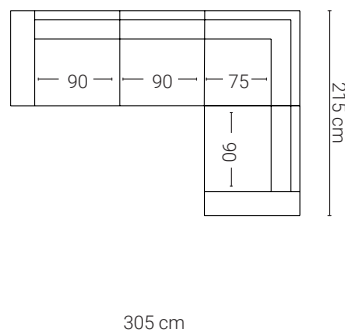

5 lugares

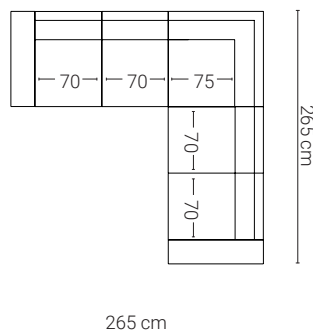

5,5 lugares

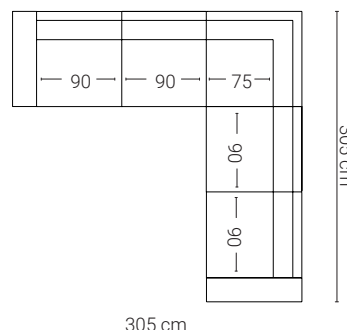

6 lugares

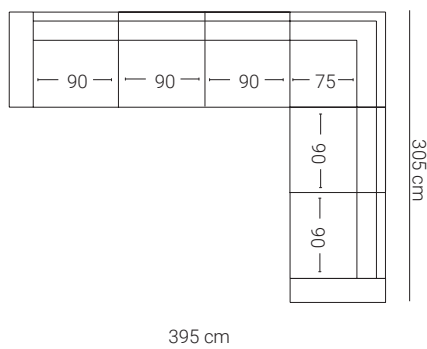

7 lugares

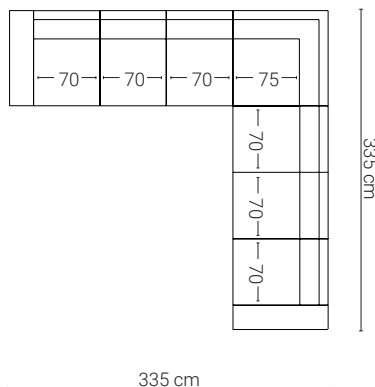

7,5 lugares

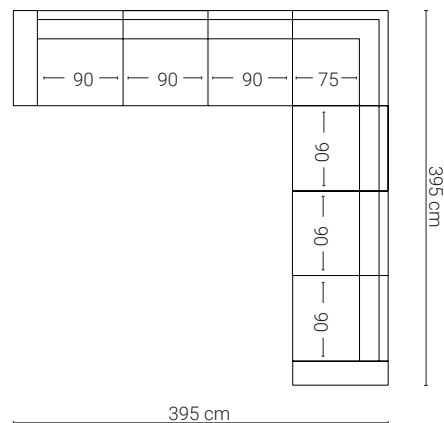

DE CANTO + PUFE

\* A posição do puff é indicada olhando de frente para o sofá.

3 lugares de canto com pufe Direita

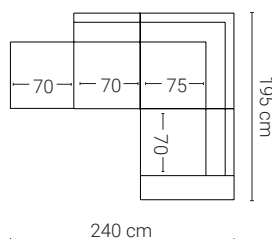

3 lugares de canto com pufe Esquerda

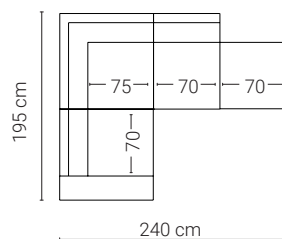

3,5 lugares de canto com pufe Direita

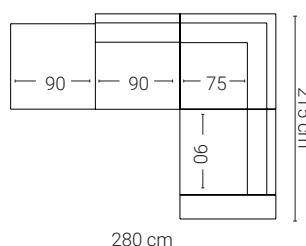

3,5 lugares de canto com pufe Esquerda

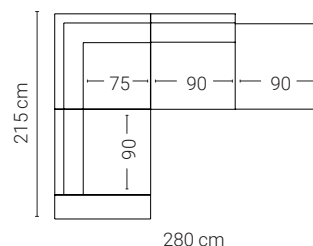

\* Existe uma tolerância de ± 2 cm por módulo.

MISURE GENERALI

\* Quote in cm

IT

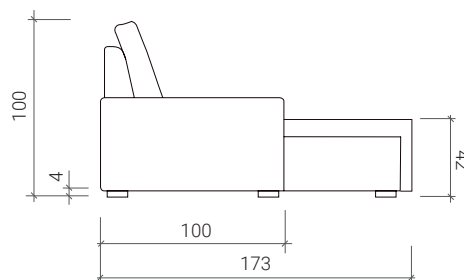
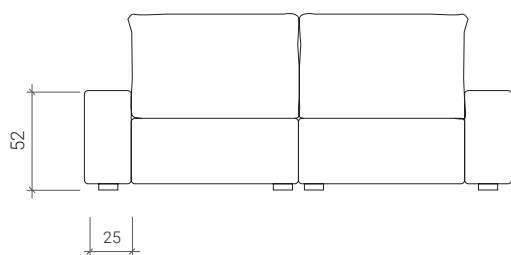
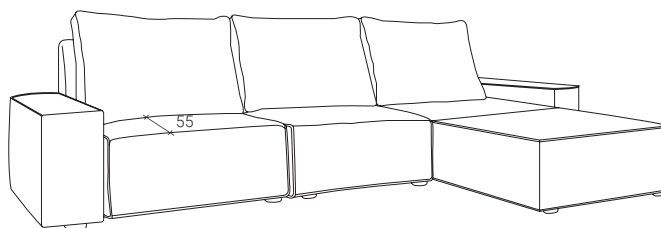
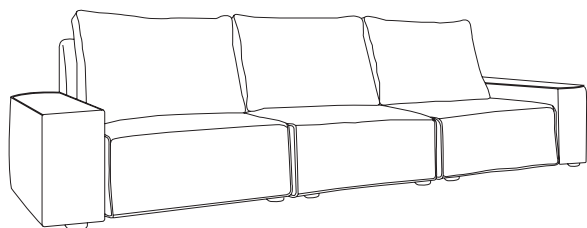

CARATTERISTICHE TECNICHE

STRUTTURA

- Legno massiccio rivestito in gomma e fibra termofusa.
- Telaio con cinghie elastiche incrociate.

COMPOSIZIONE

- Seduta e schienale: Gomma ad alta resistenza da 30 kg rivestita con fibra termofusa antiallergica.
- Gambe: PVC (nascoste). Finitura nera.

CUSCINI DECORATIVI

- Include 2 cuscini da 40 x 40 cm nei modelli con chaise longue.

SPECIFICHE DI MONTAGGIO

- Non richiede montaggio. È necessario solo unire i moduli tramite le staffe già installate.

Sedile rimovibile	No
Schienale reclinabile	No
Sfoderabile	- Sedili - Schienali
Cassapanca	No
Opzione braccioli rimovibili	No
Modulo angolare	Sì



COMPOSIZIONI

IT

SENZA CHAISE LONGUE

2 posti

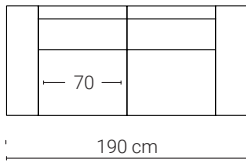

2,5 posti

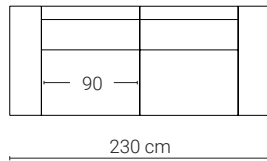

3 posti

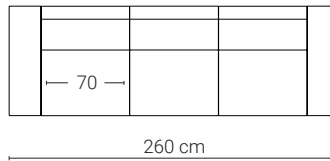

3,5 posti

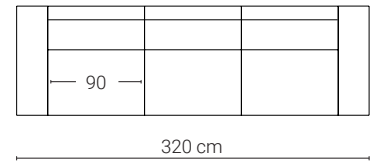

CON CHAISE LONGUE

\* La posizione della sedia si indica guardando frontalmente il divano.

2 posti con chaise longue  
Destra Medio

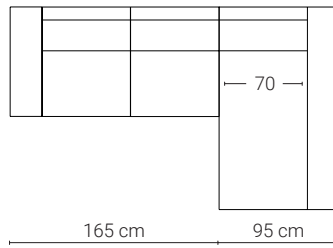
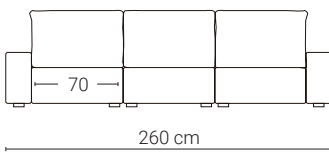

2 posti con chaise longue  
Sinistra Medio

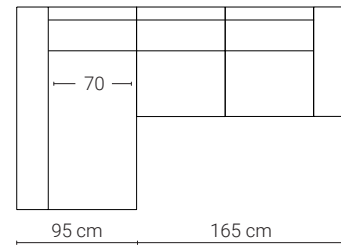

2,5 posti con Chaise Longue  
Destra Grande

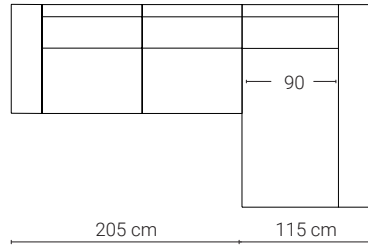
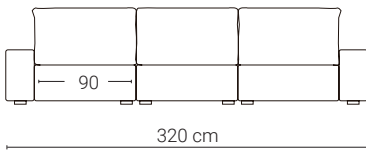

2,5 posti con chaise longue  
Sinistra Grande

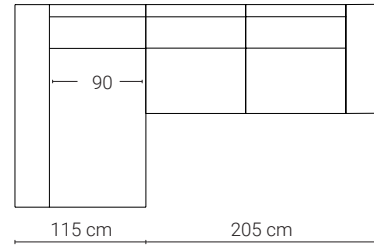

3 posti con chaise longue  
Destra Grande

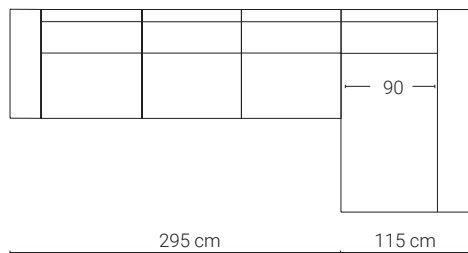
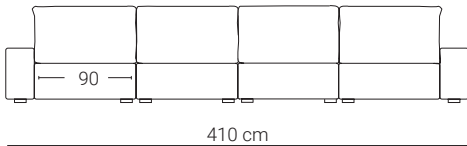

3 posti con Chaise Longue  
Sinistra Grande

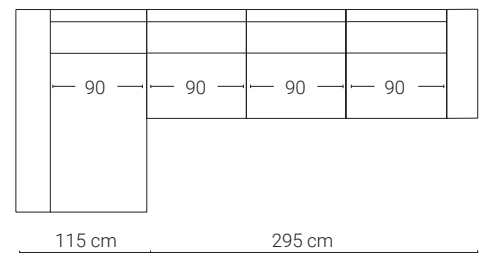

CON POUF

\* La posizione del pouf si indica guardando frontalmente il divano.

3 posti + pouf

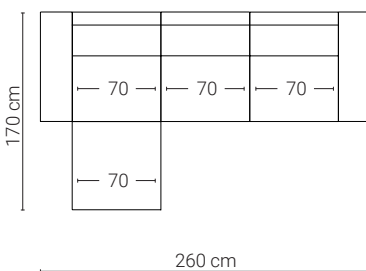

3,5 posti + pouf

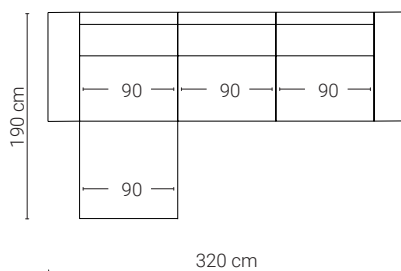

4 plazas + pouf

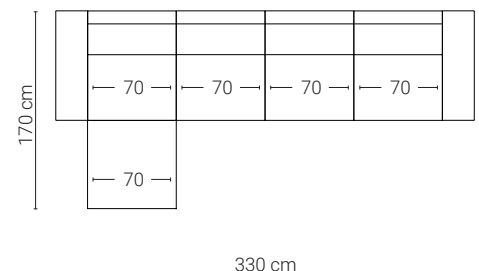

\* Esiste una tolleranza di  $\pm 2$  cm per modulo.

COMPOSIZIONI

IT

CON POUF

\* La posizione del pouf si indica guardando frontalmente il divano.

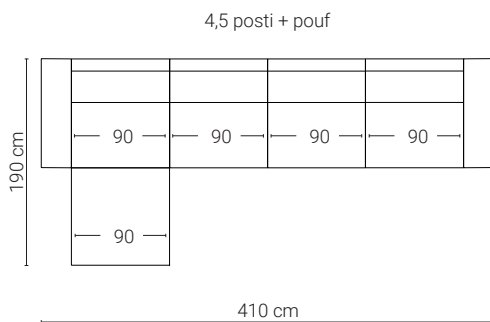

ANGOLO

\* La posizione del pouf si indica guardando frontalmente il divano.

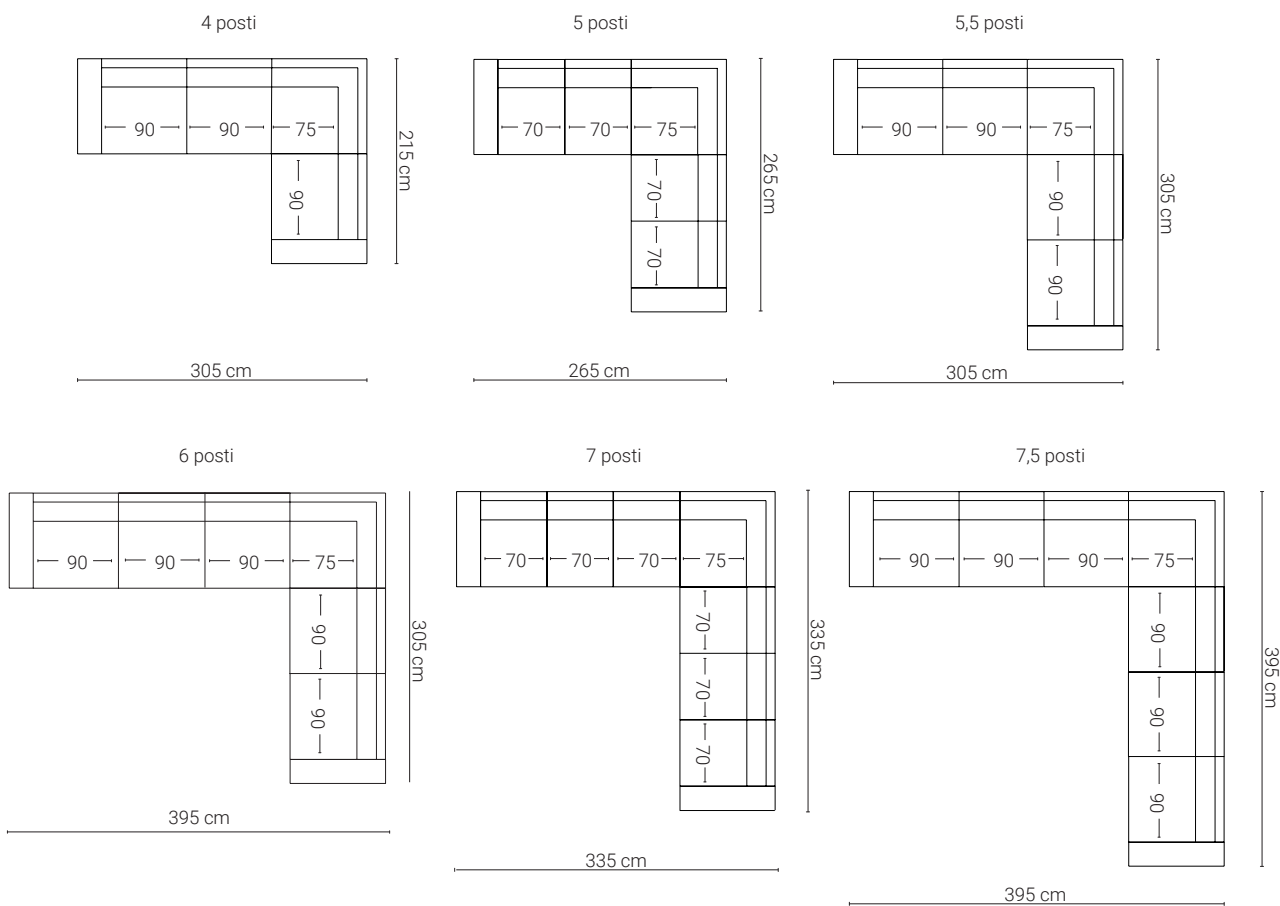

ANGOLO + POUF

\* La posizione del pouf si indica guardando frontalmente il divano.

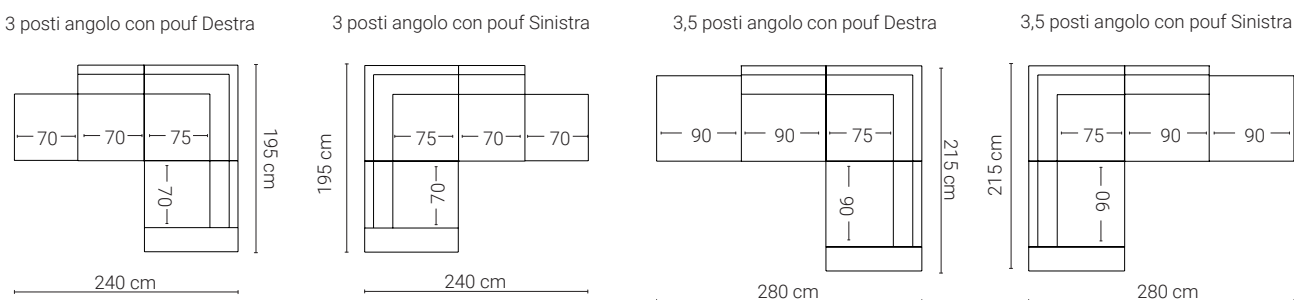

\* Esiste una tolleranza di  $\pm 2$  cm per modulo.

LES MESURES GÉNÉRALES

\* Dimensions en cm

FR

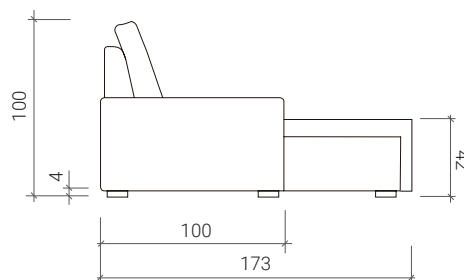
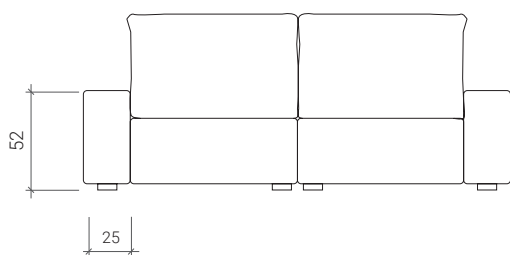
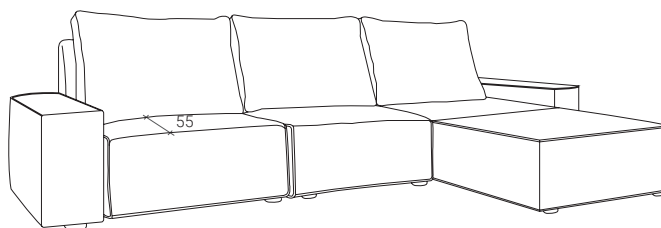
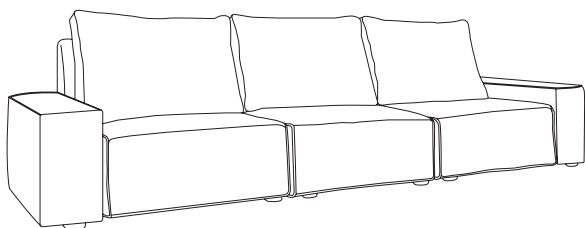

SPÉCIFICATIONS TECHNIQUES

STRUCTURE

- Bois massif recouvert de caoutchouc et de fibre thermofusible.
- Cadre en sangle élastique avec sangles croisées.

COMPOSITION

- Assise et dossier: Caoutchouc haute résistance 30 kg recouvert de fibre thermofusible anallergique.
- Pieds: PVC (caché). Finition noire.

COUSSINS DÉCORATIFS

- Coussins décoratifs non inclus.

SPÉCIFICATIONS DE L'ASSEMBLAGE

- Aucun assemblage n'est nécessaire. Il suffit de connecter les modules à l'aide des plaques déjà installées.

Siège amovible	Non
Dossier inclinable	Non
Amovible	- Sièges - Sauvegardes
Arcón	Non
En option, détachable amovible	Non
Module d'angle	Oui

## COMPOSITIONS

FR

### SANS CHAISE LONGUE

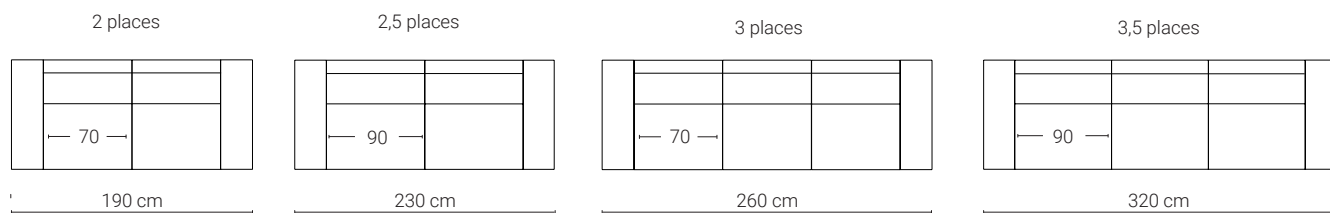

### AVEC CHAISE LONGUE

\* La position de la chaise est indiquée en regardant l'avant du canapé.

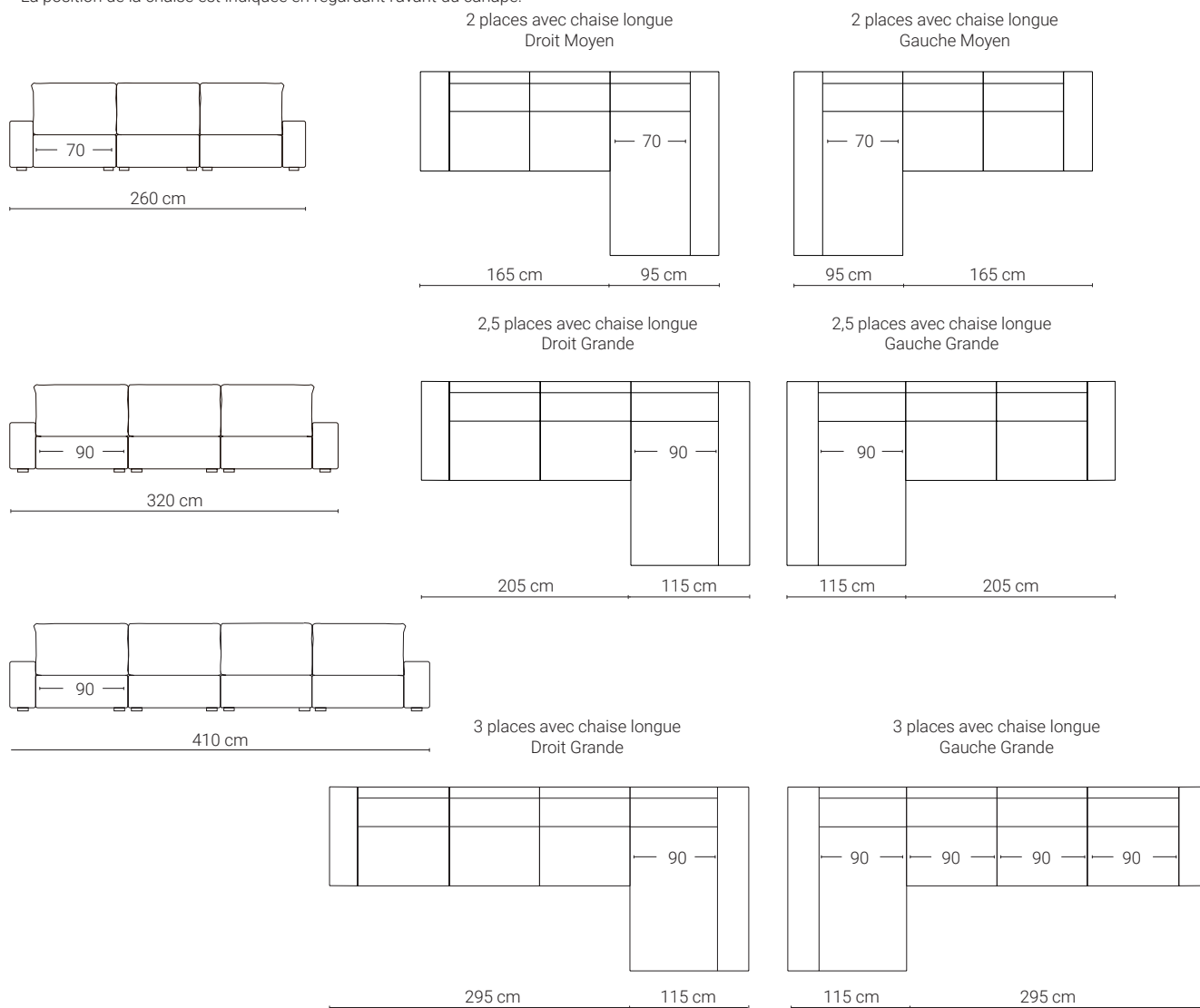

### POUF

\* La position du pouf est indiquée en faisant face au canapé.

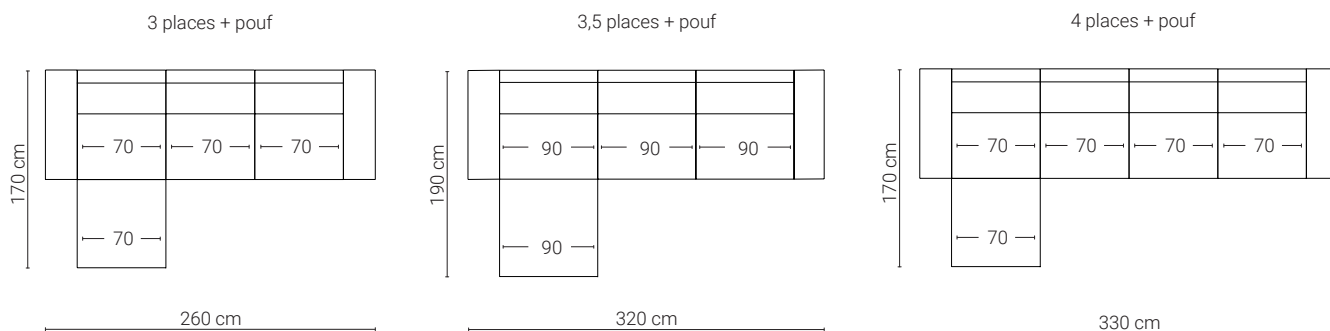

\* Il y a une tolérance de  $\pm 2$  cm par module.

## COMPOSITIONS

FR

### POUF

\* La position du pouf est indiquée en faisant face au canapé.

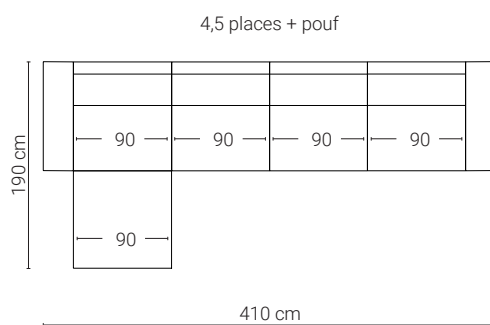

### COIN

\* La position du pouf est indiquée en faisant face au canapé.

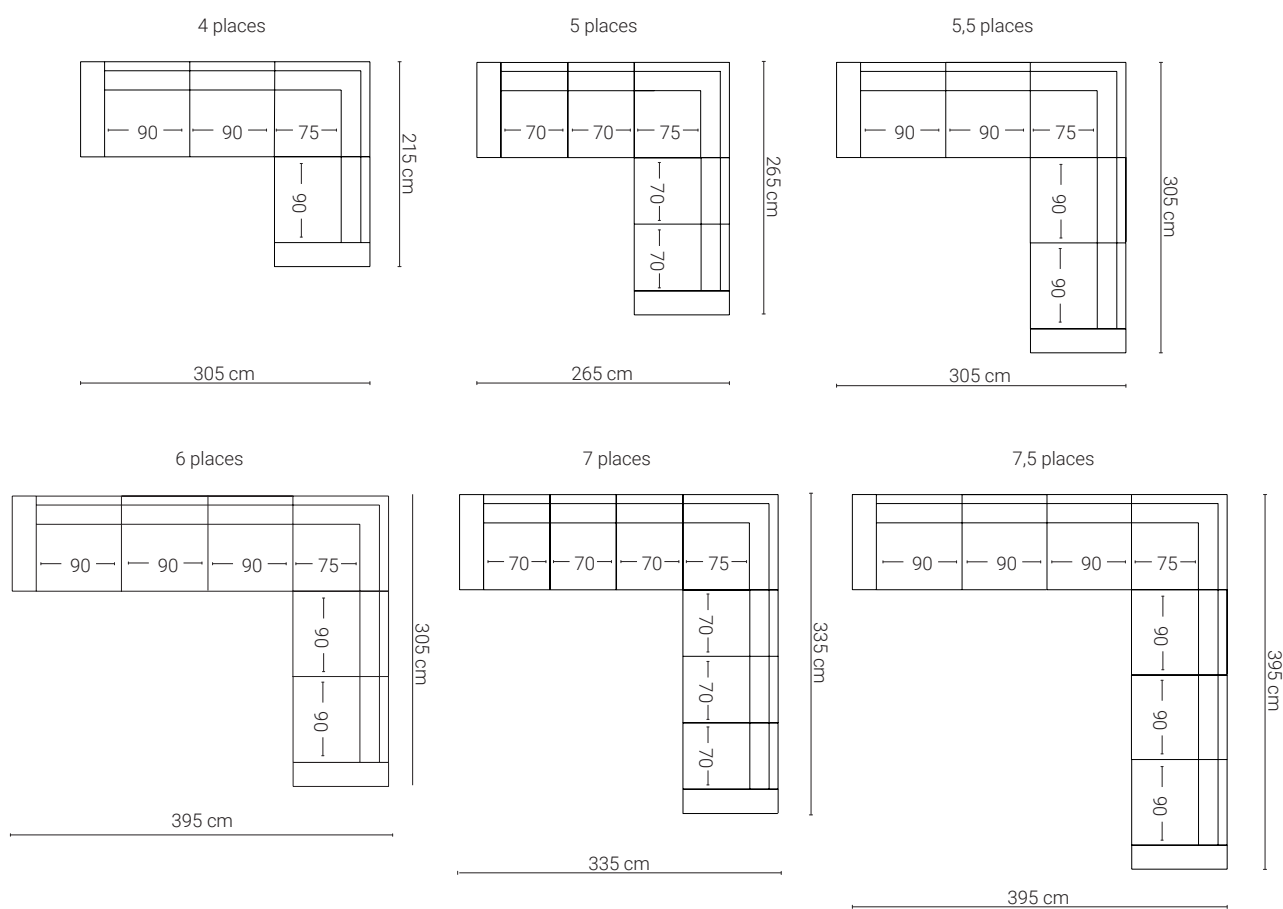

### COIN + POUF

\* La position du pouf est indiquée en faisant face au canapé.

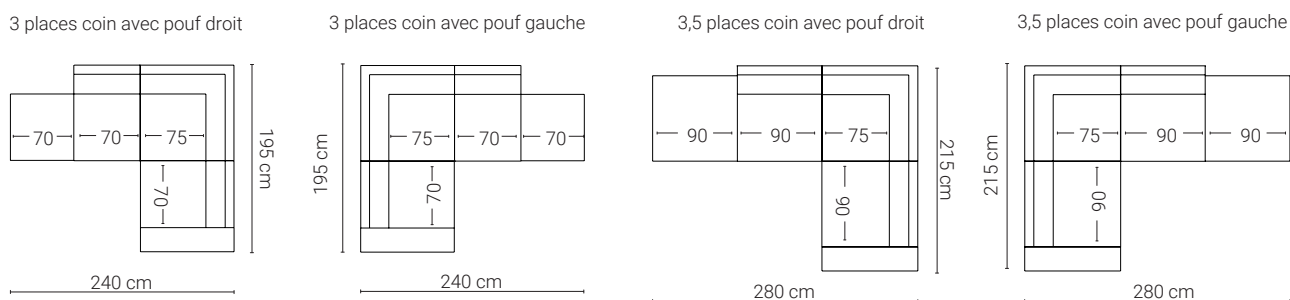

\* Il y a une tolérance de  $\pm 2$  cm par module.

GENERAL MEASURES

\* Dimensions in cm

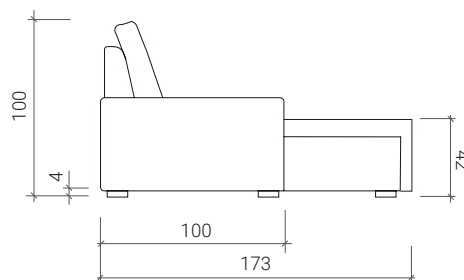
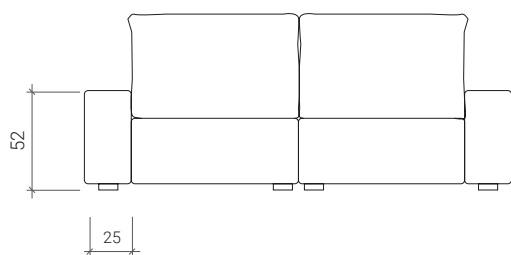
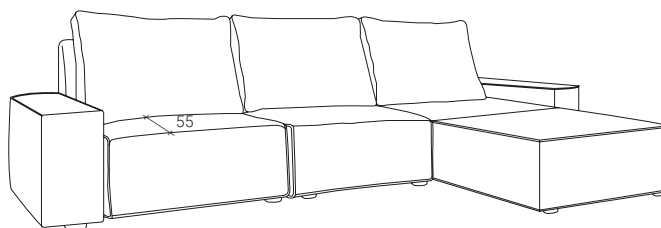
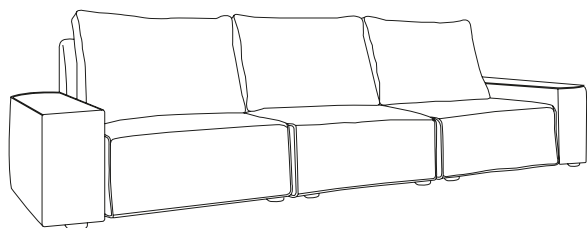

TECHNICAL CHARACTERISTICS

STRUCTURE

- Solid wood covered with rubber and thermofused fibre.
- Frame with interwoven elastic webbing.

COMPOSITION

- Seat and back: 30 kg high-strength rubber covered with anti-allergenic thermofused fibre.
- Legs: PVC (concealed). Black finish.

DECORATIVE CUSHIONS

- Decorative cushions not included.

ASSEMBLY SPECIFICATIONS

- No assembly required. Only the connection between modules by means of pre-installed plates is necessary.

Removable seat	No
Reclining backrest	No
Removable	- Seats - Backrests
Storage	No
Optional arms removable	No
Corner module	Yes

COMPOSITIONS

WITHOUT CHAISE LONGUE

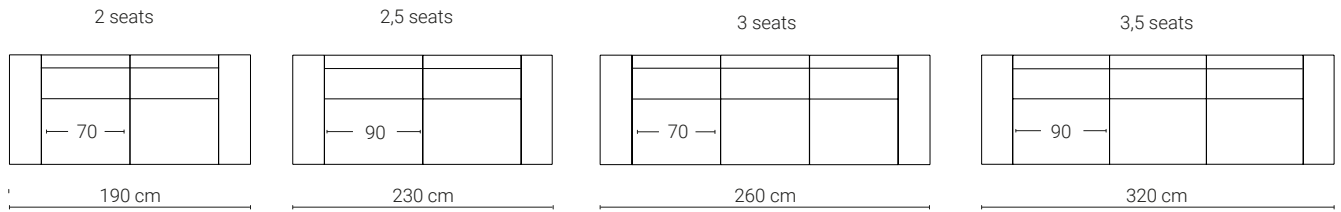

WITH CHAISE LONGUE

\* The position of the chaise is indicated by looking at the front of the sofa.

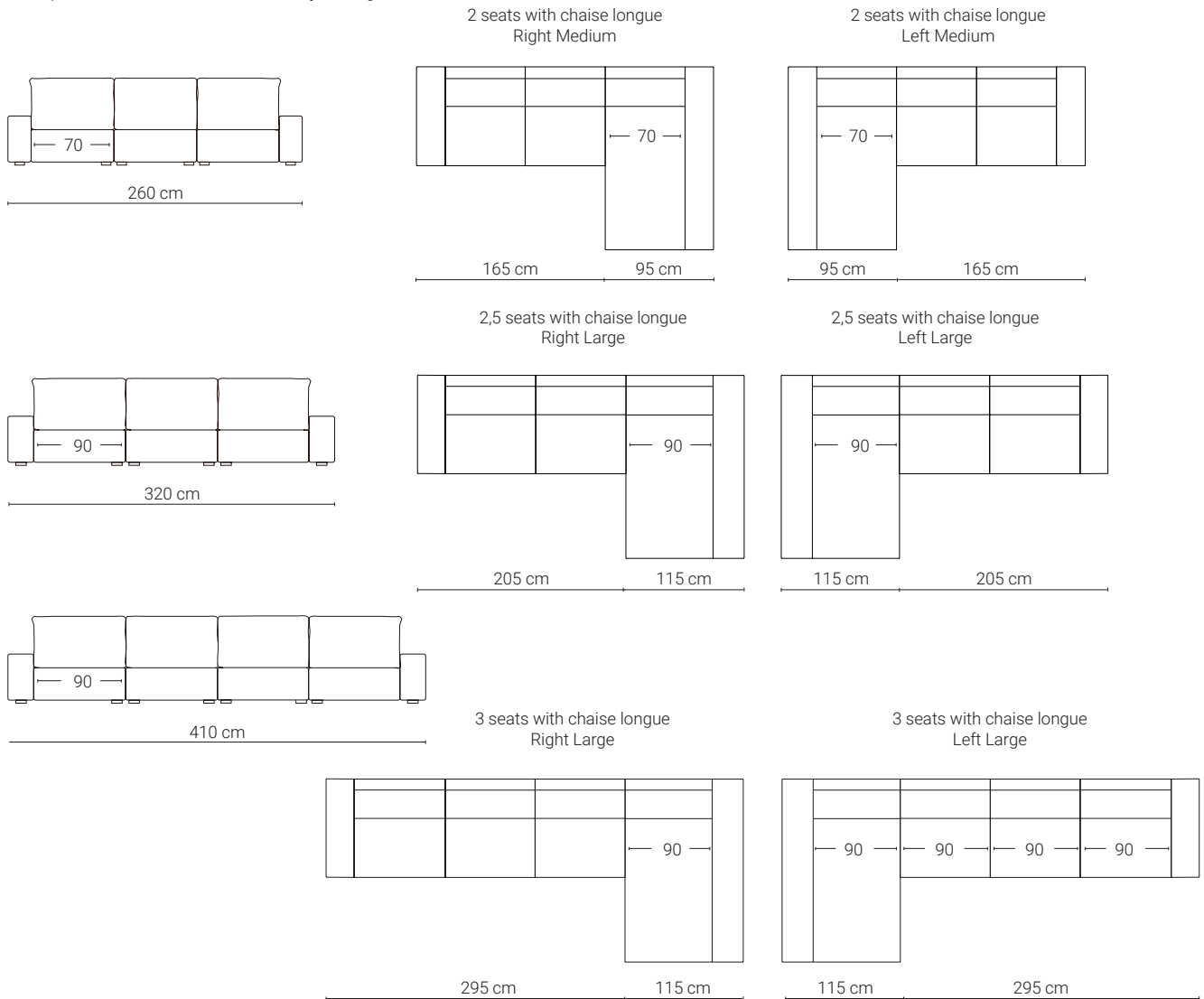

WITH PUF

\* The position of the pouffe is indicated facing the sofa.

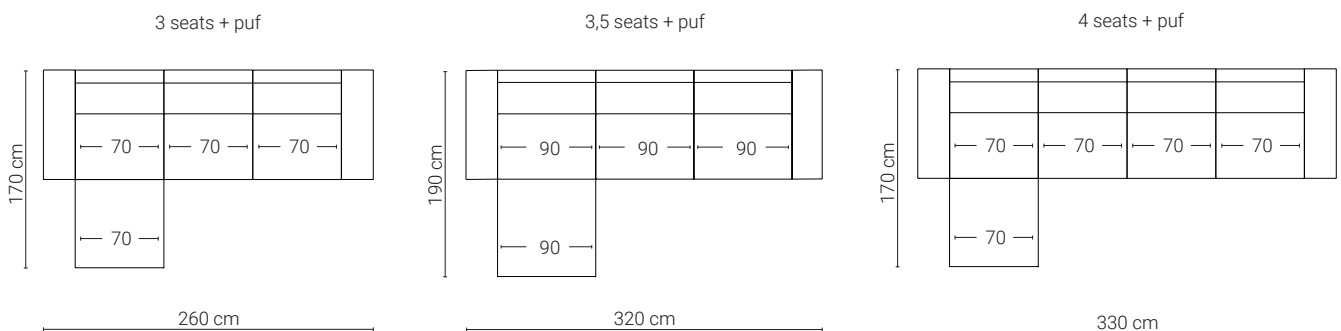

\* There is a tolerance of ± 2 cm per module.

COMPOSITIONS

EN

WITH PUF

\* The position of the pouffe is indicated facing the sofa.

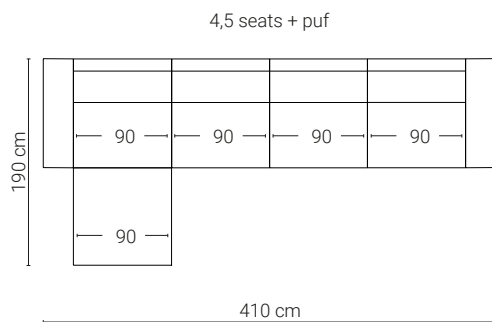

CORNER

\* The position of the pouffe is indicated facing the sofa.

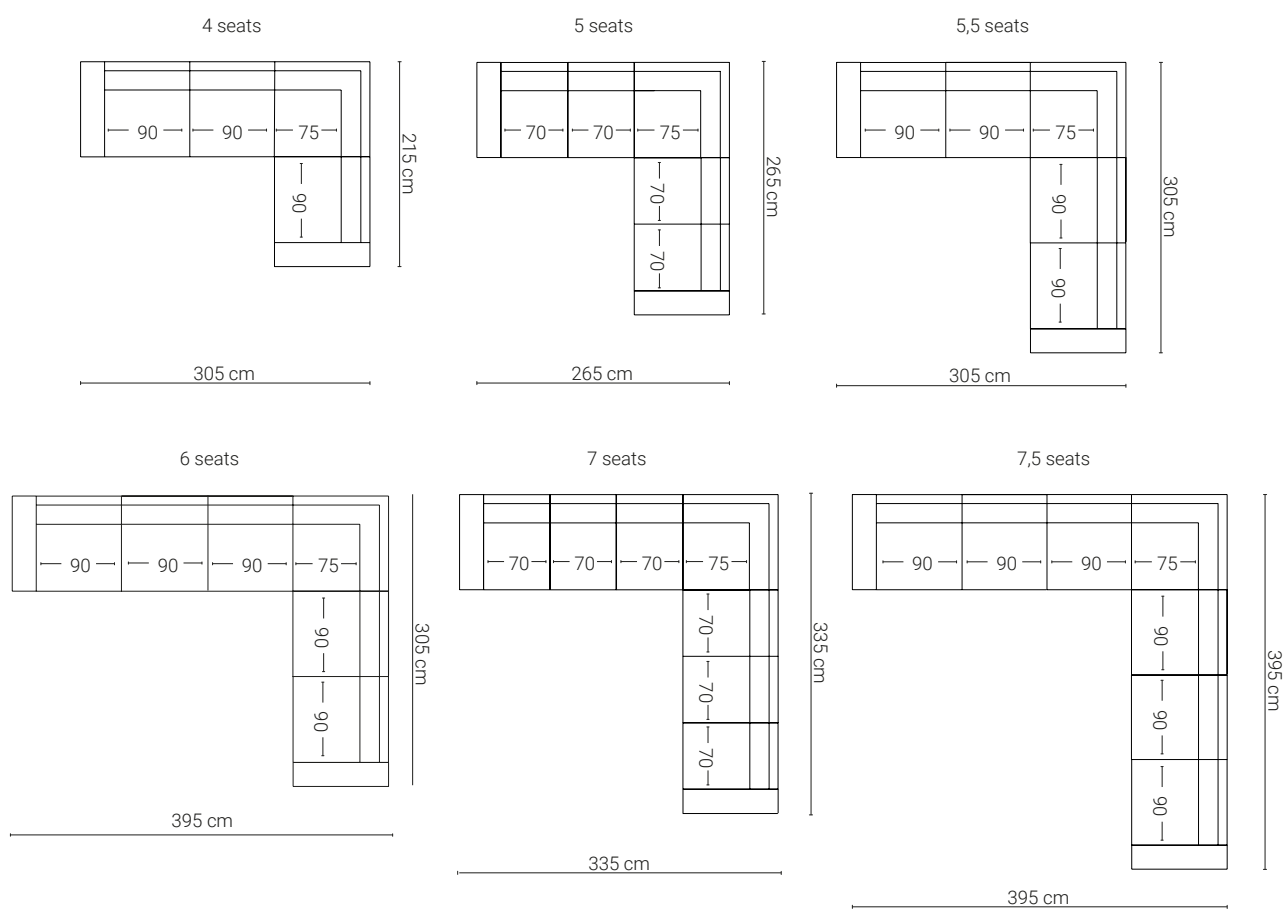

CORNER + PUF

\* The position of the pouffe is indicated facing the sofa.

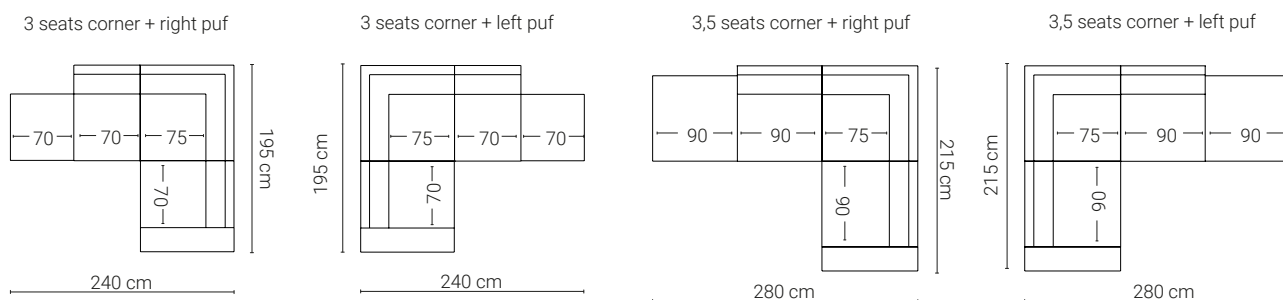

\* There is a tolerance of ± 2 cm per module.



**ALLGEMEINE MASSNAHMEN**

\* Abmessungen in cm

DE

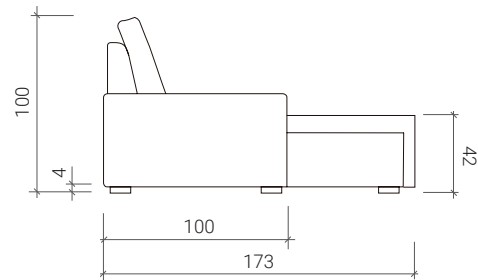
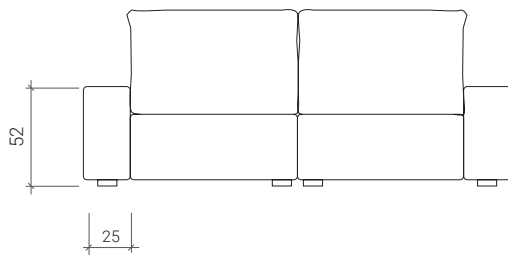
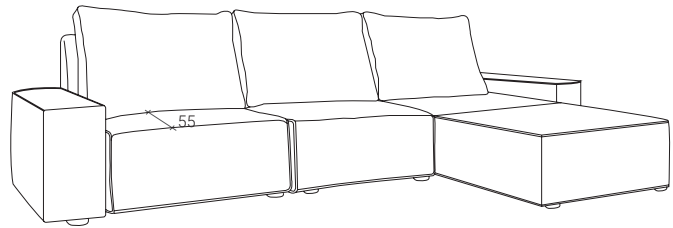
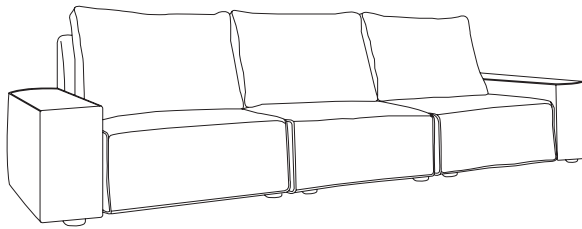

**TECHNISCHE MERKMALE**

**STRUKTUR**

- Massivholz mit Gummi- und Thermofaserbeschichtung.
- Rahmen mit eingewebtem elastischem Gurtband.

**ZUSAMMENSETZUNG**

- Sitz und Rückenlehne: 30 kg hochfester Kautschuk, bezogen mit antiallergischer, thermofixierter Faser.
- Beine: PVC (verdeckt). Schwarzes Finish.

**DEKORATIVE KISSEN**

- Deko-Kissen nicht enthalten.

**MONTAGESPEZIFIKATIONEN**

- Keine Montage erforderlich. Es ist nur notwendig, die Module mit Hilfe der bereits installierten Platten zu verbinden.

Abnehmbarer Sitz	Nein
Verstellbare Rückenlehne	Nein
Abnehmbar	- Sitze - Rückenlehnen
Truhe	Nein
Optional abnehmbar abnehmbar	Nein
Eckmodul	Ja

ZUSAMMENSETZUNGEN

OHNE CHAISE LONGUE

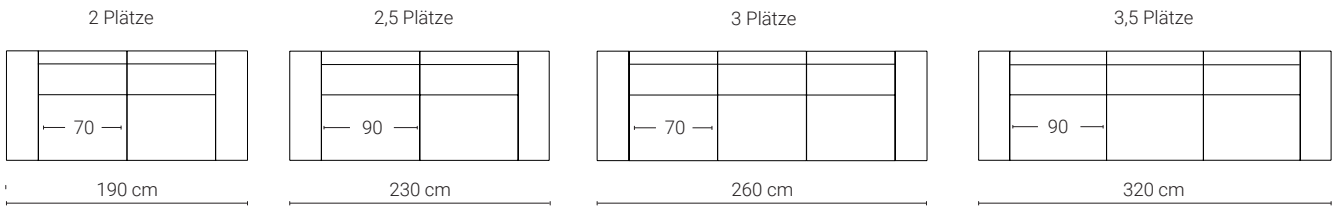

MIT CHAISE LONGUE

\* Die Position der Liege wird durch den Blick auf die Vorderseite des Sofas angezeigt.

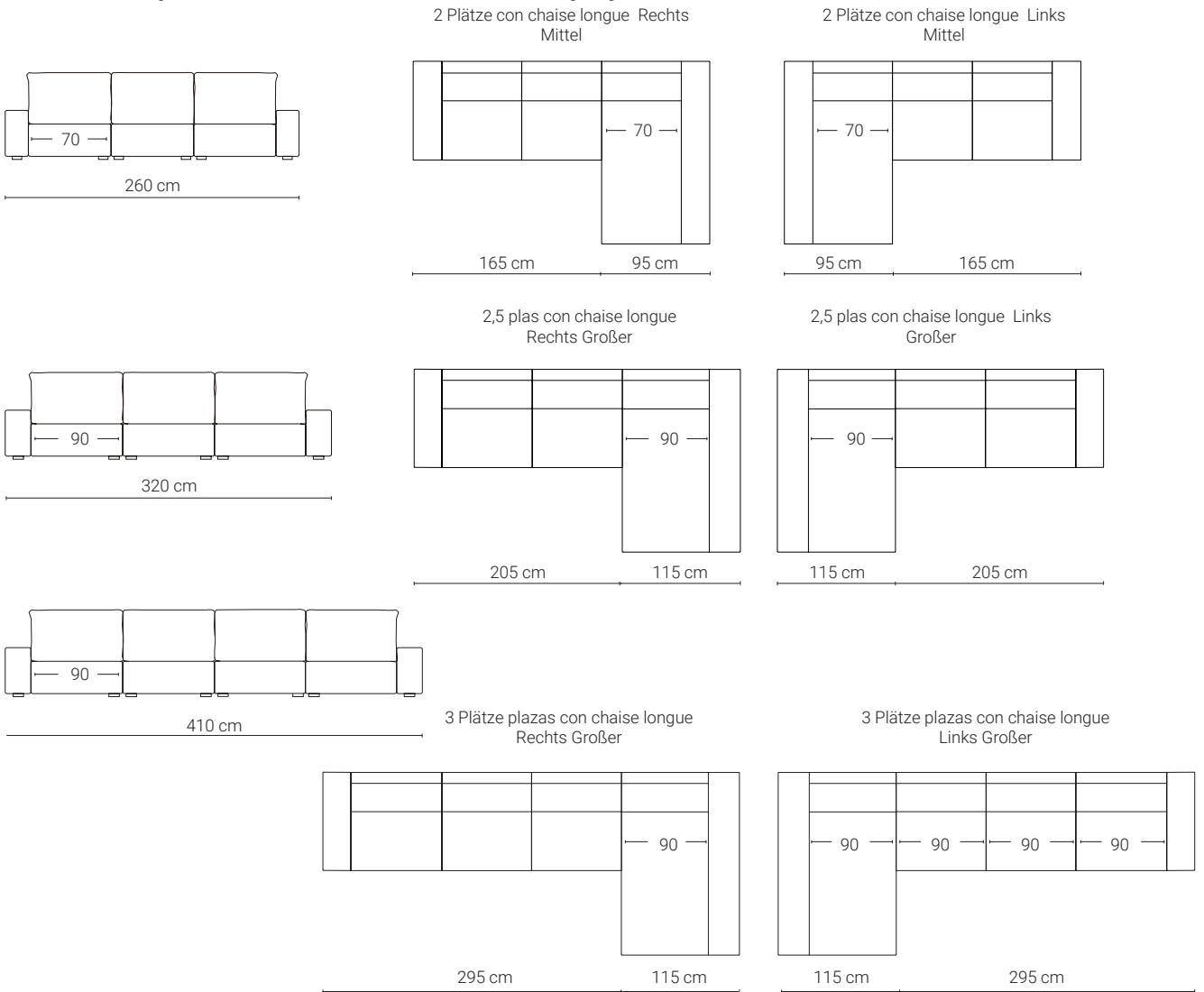

PUFF

\* Die Position des Puffes wird durch die Ausrichtung des Sofas angezeigt.

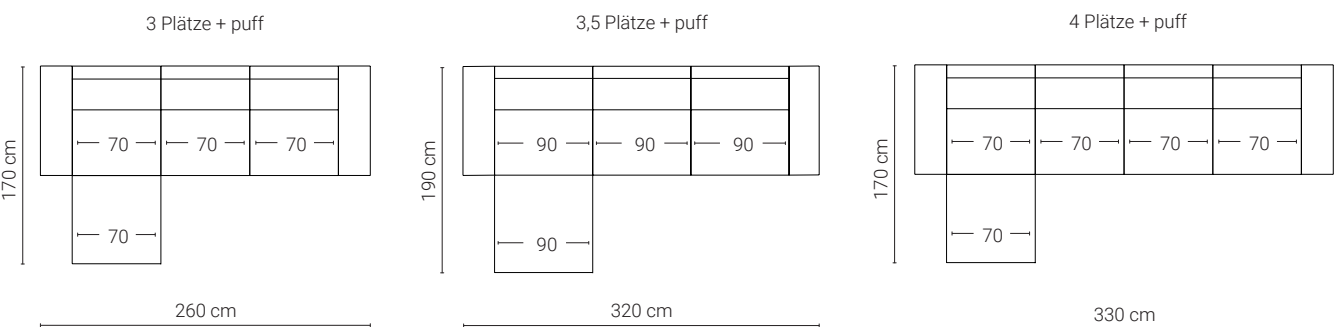

\* Es besteht eine Toleranz von ± 2 cm pro Modul.

ZUSAMMENSETZUNGEN

DE

PUFF

\* Die Position des Puffes wird durch die Ausrichtung des Sofas angezeigt.

4,5 Plätze + puff

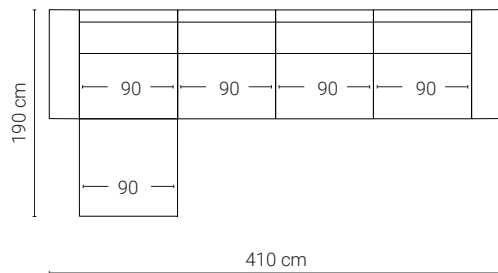

ECKMODUL

\* Die Position des Puffes wird durch die Ausrichtung des Sofas angezeigt.

4 Plätze

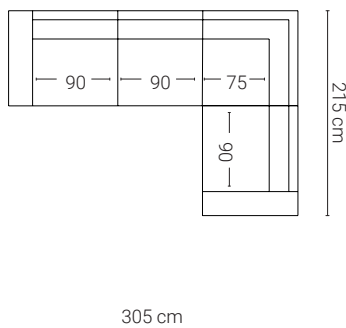

5 Plätze

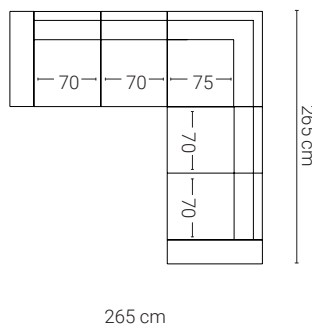

5,5 Plätze

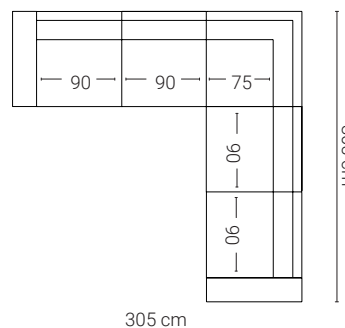

6 Plätze

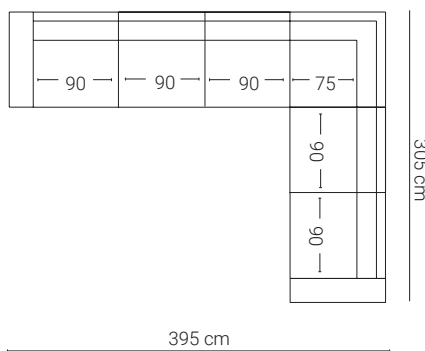

7 Plätze

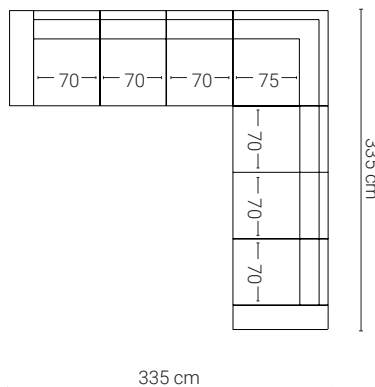

7,5 Plätze

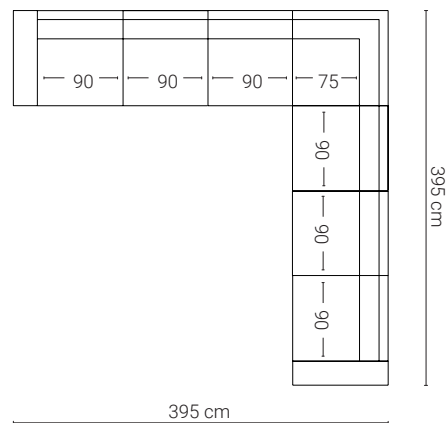

ECKMODUL + PUFF

\* Die Position des Puffes wird durch die Ausrichtung des Sofas angezeigt.

3 Plätze Ecke mit Puff rechts

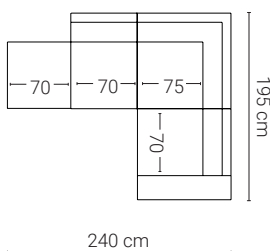

3 Plätze Ecke mit Puff links

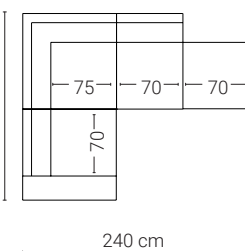

3,5 Plätze Ecke mit Puff rechts

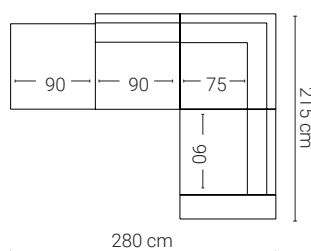

3,5 Plätze Ecke mit Puff links

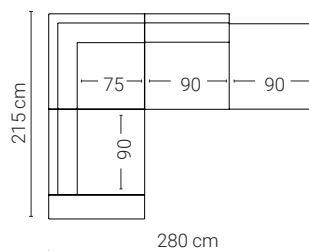

\* Es besteht eine Toleranz von ± 2 cm pro Modul.